

P- Channel 30V (D-S) MOSFET

Typical Characteristics (T_J =25°C Noted)

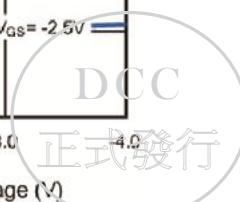
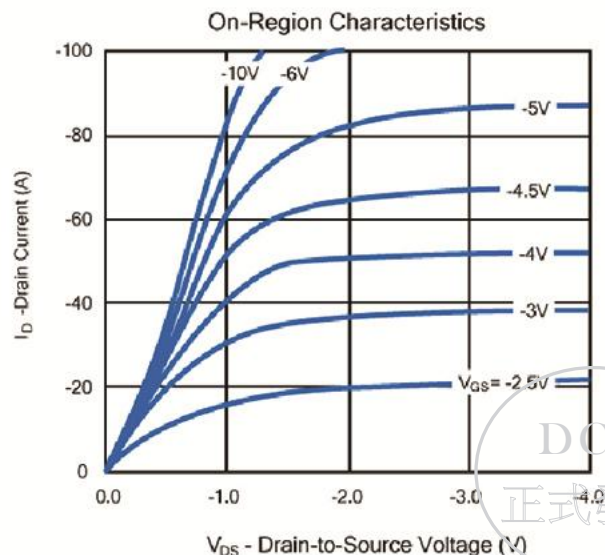
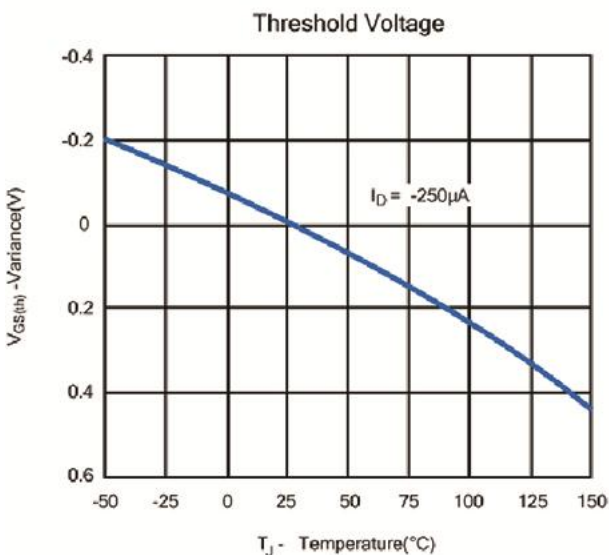
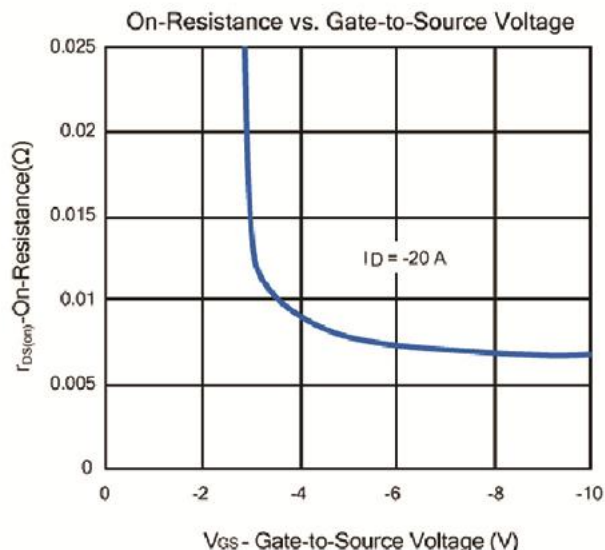
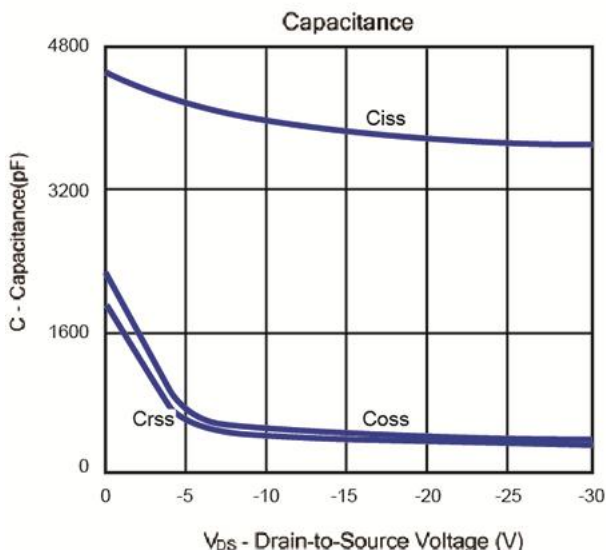
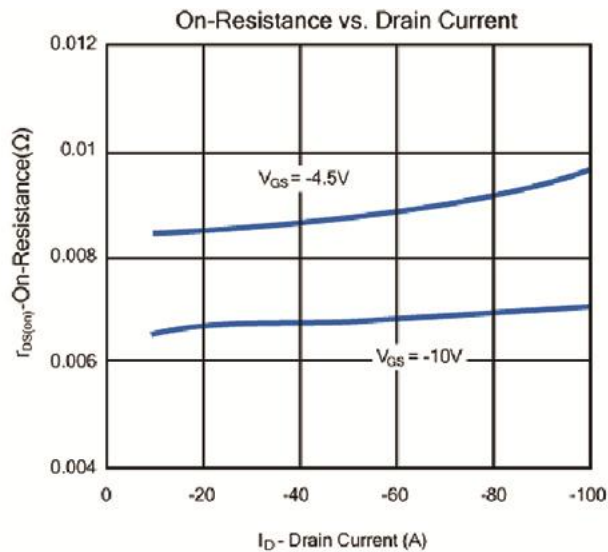
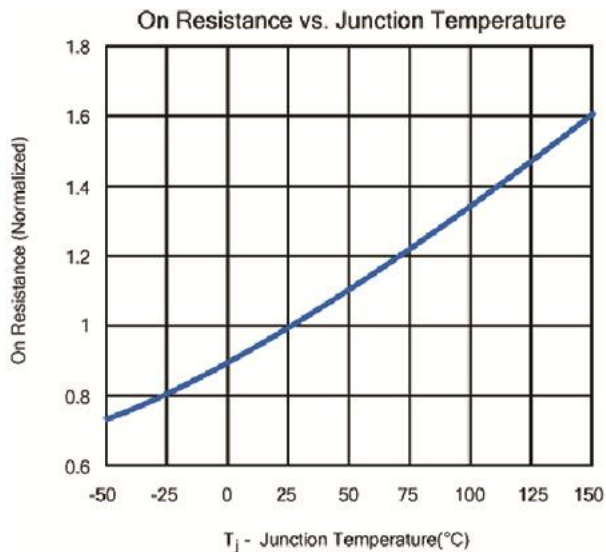

P- Channel 30V (D-S) MOSFET

Typical Characteristics (T_J = 25°C Noted)

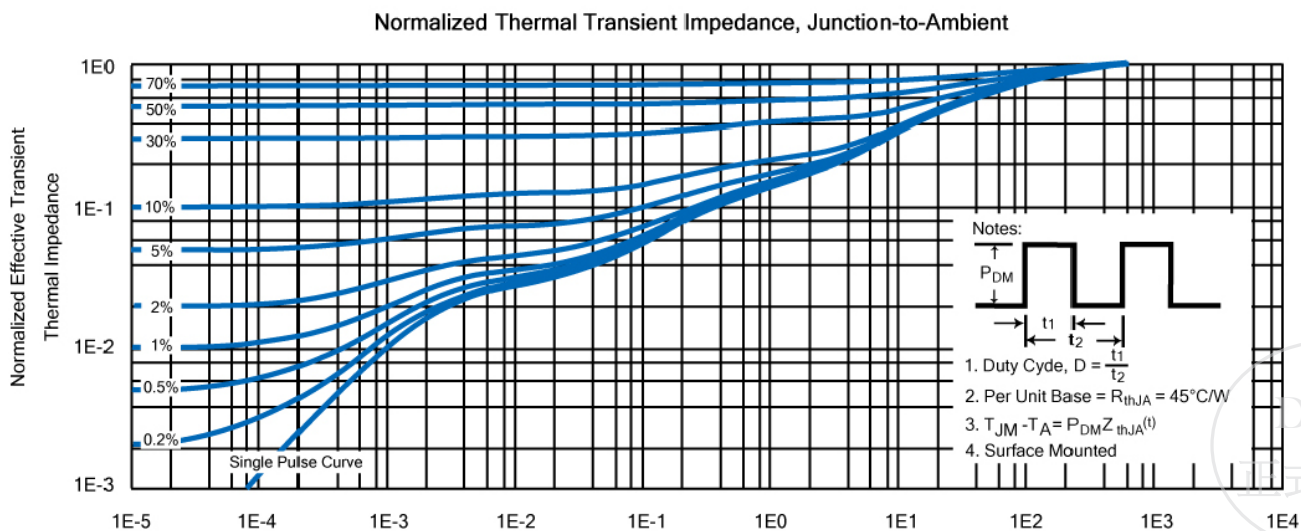
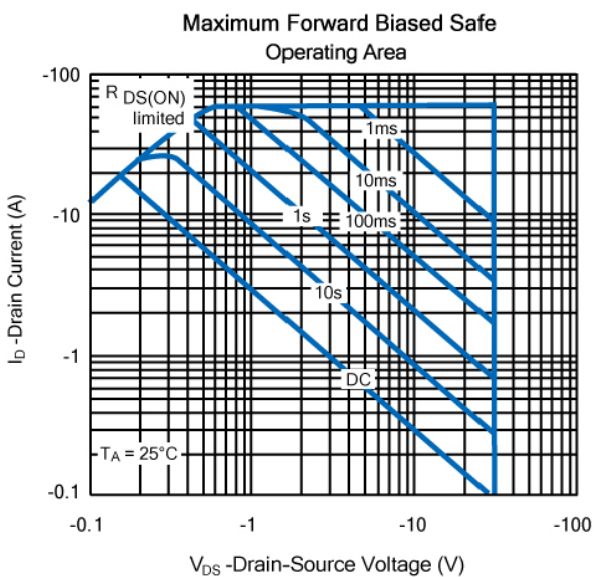
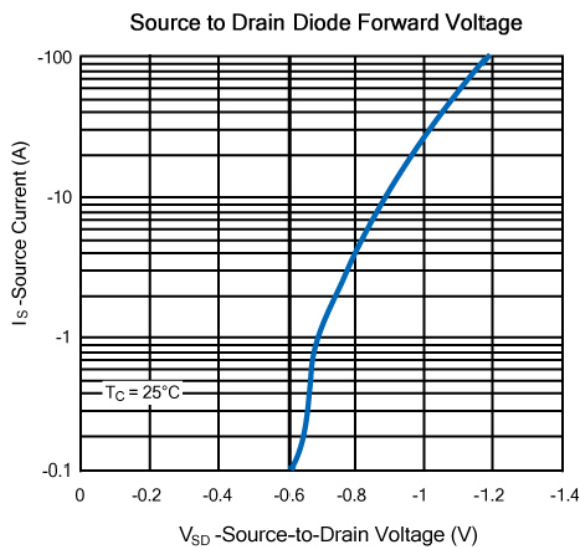
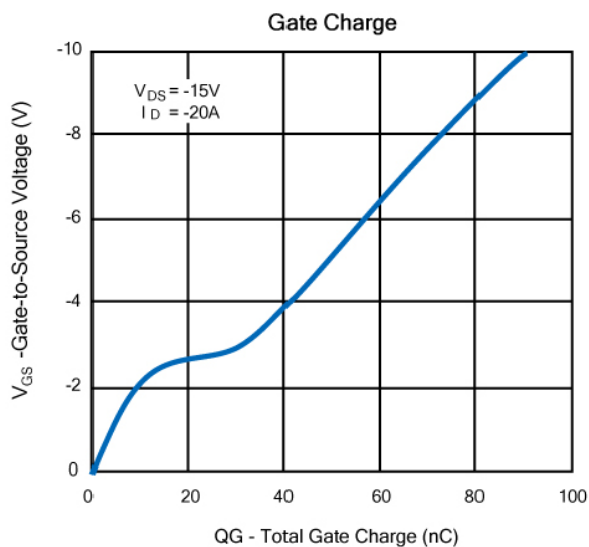

TO-252 Package Outline

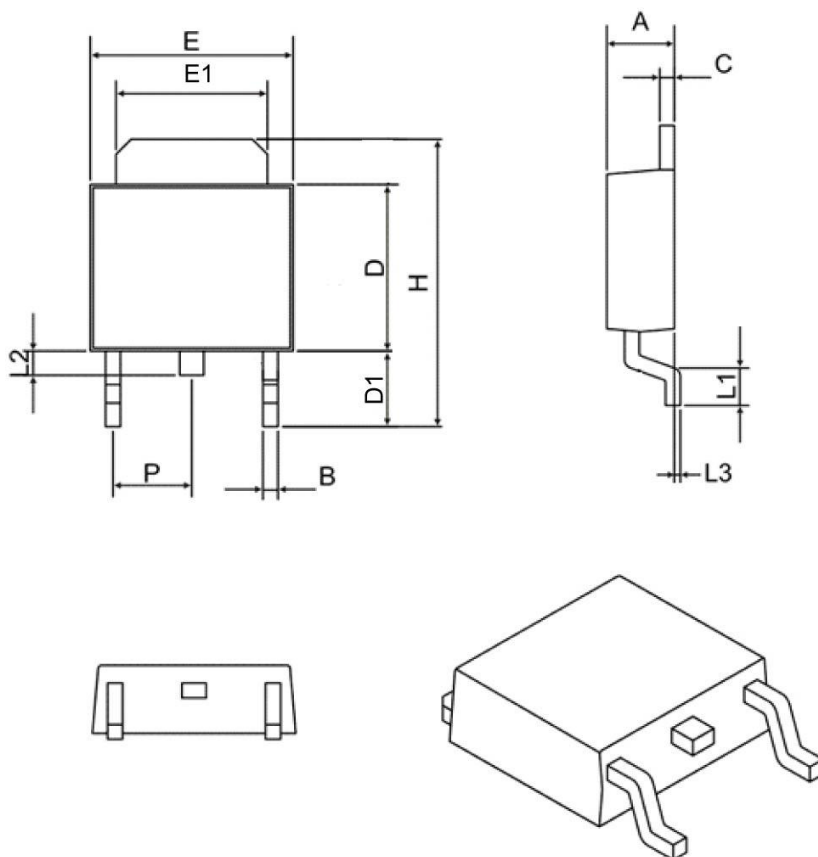

SYMBOL	MIN	MAX
A	2.10	2.50
B	0.40	0.90
C	0.40	0.90
D	5.30	6.30
D1	2.20	2.90
E	6.30	6.75
E1	4.80	5.50
L1	0.90	1.80
L2	0.50	1.10
L3	0.00	0.20
H	8.90	10.40
P	2.30 BSC	

